



MARETTI

L I G H T I N G



Maretti Lighting
Bolderweg 7

1332 AX Almere
the Netherlands

T +31 (0) 36 532 66 12

E info@maretti.com
W www.maretti.com

Maretti Lighting is well-known in the World of interior design. In businesses, homes, store chains, and hospitality facilities all over the world, Maretti is unmistakable present with its project lighting that does more than just provide light. We make lighting an essential part of the interior. Maretti stands for stylish top quality and trendsetting design, modern, timeless and most of all, original.

Maretti Lighting works with all the top brands in the lighting industry, but we are especially notable for our own large product line and introduce our own brand name "Maretti". Our production team distinguishes itself time and time again with unique innovations from our own atelier and therefore our projects exude an entirely unique identity.

© Copyright Maretti Projectverlichting.

Our IM was made with the greatest of care. Nevertheless, the colours displayed in the IM may differ slightly from the real colours because of the printing process. Colour, size and range are subject to change. Nothing from this IM may be copied, reproduced and/or published by print, photocopy or in any other way without Maretti Lighting's written permission. All product and design copyrights belong to Maretti Lighting.

GUARANTEE TERMS AND CONDITIONS

The other party should inspect the delivered items immediately upon receipt with regard to its soundness. Entitlements to repair or replacement only exist if the other party

- In the case of visible defects, informs MPV of them immediately.

- In the case of defects that are not visible, informs MPV in writing of the defects, within 2 working days after the day the defects were found, or in all reason could have been found and furthermore demonstrates that the MPV instructions for use, maintenance and operation were followed, whilst the defects are not the consequence of normal wear and tear, misuse, negligence, accident, exceeding the limits prescribed by the MPV or by the legal safety regulations, or, in the case of a repair or change without MPV's consent or the consent of its recognised repairer, there will be no entitlement to repairs or replacement. The parts that have to be replaced must be made available free of charge to MPV. Noncompliance by the other party to one or more of its obligations will release MPV of all its guarantee obligations. In the case of assembly of the other party's own products by Maretti, MPV will release itself from all guarantee stipulations.

Moreover, our general delivery terms and conditions are applicable. These can be obtained from Maretti or can be downloaded from www.maretti.com

The installation must be done by a competent installer. Maretti recommends that your (outside) lighting and fixtures are inspected and maintained annually.

D: Für Garantiebedingungen bitte lesen Sie unsere Webseite www.maretti.com
E: Consulte nuestro sitio web para los condiciones de garantía www.maretti.com
FR: Consultez notre site web pour les conditions de garantie www.maretti.com
NL: Voor garantievoorwaarden zie onze website www.maretti.com

11.2813.COLOUR.A

DISCUS 50 RECESSED SPOT

1/3



TILTABLE

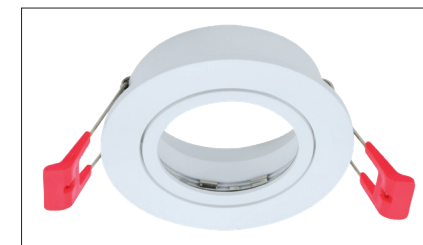

CHROME BLACK WHITE



max. 20W	MAX. WATTAGE	IP20	IP RATING		
	BULB NOT INCLUDED		TILTABLE LIGHT		
	DRIVER NOT INCLUDED	CE	CE MARK		
	INDOOR				

LET OP! VOOR DEZE VERSIE MOET U EXTRA ACCESSOIRES BESTELLEN: GU10 LAMPHOUDER EN EEN GU10 LICHTBRON
 NOTE! FOR THIS VERSION YOU HAVE TO ORDER EXTRA ACCESSORIES: GU10 LAMPHOLDER AND A GU10 LIGHT SOURCE

LICHTBRON: APART VERKRIJGBAAR / LIGHT BULB: SEPARATE ORDER								
ART. NR.	NAME	SOCKET	VOLTAGE	WATTAGE	KELVIN	LUMEN	CRI	BEAM ANGLE
21.8550.92	DOMINGO 50 LED	GU10	230V	5,5W	2700K	350 lm	Ra90	38°
21.8555.92	DOMINGO 50 LED	GU10	230V	5,5W	CTA 2200-2800K	350 lm	Ra90	38°

LAMPHOUDER: APART VERKRIJGBAAR / LAMP HOLDER: SEPARATE ORDER			
ART. NR.	NAAM / NAME	SOCKET	VOLTAGE
70.7220.00	LAMP HOLDER FOR GU10	GU10	230V

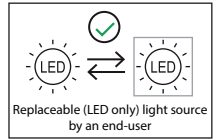

UIT/ OFF

Schakel altijd eerst de stroom uit voordat u installatie-, onderhoud of reparatiewerkzaamheden uitvoert.

Always switch off the mains voltage before carrying out installation, maintenance and repair work.

1

Cut hole size
Zaagmaat
Ø70mm

2

Maten met de lamphouder:
Inbouwhoogte advies 120mm
Measurements with the lamp holder:
Installation height advice 120mm

Het is mogelijk om de lamphouder te kantelen.
 It is possible to tilt the lamp holder.

3

Verwijder de beugel, vervang door de lamphouder
 Remove the bracket, replace with the lamp holder

4

Apart verkrijgbaar
Separate order

Not included
Niet meegeleverd

5

Apart verkrijgbaar
Separate order

Not included
Niet meegeleverd

6

7

8

Spot kantelen /
Tilt spot

LICHTBRON
VERVANGEN /
REPLACING
LIGHT SOURCE

inkeep / notch

Verwijder de spot ring met behulp van een schroevendraaier /
Remove the spot ring using a screwdriver



LET OP: Volg en bewaar deze gebruiksaanwijzing.
 - Zorg ervoor dat de netspanning uitgeschakeld is voor installatie, reparatie of onderhoud. (Installatie, reparatie en onderhoud uitsluitend door gekwalificeerde personen).
 - Voor reparatie of onderhoud uitsluitend originele delen gebruiken. Probeer het product niet zelf te demonteren en te repareren, onjuiste reparaties kunnen het product beschadigen en elektrische schokken veroorzaken wat tot ernstig letsel kan leiden.
 - Gebruik het armatuur alleen binnenshuis. Het armatuur niet in vochtige of natte ruimte gebruiken.
 - Uitsluitend op het etiket aangegeven lichtbronnen gebruiken.

Wanneer u een spot inbouwt moet u rekening houden met de warmte en dus rekening houden met extra inbouwruimte rond je armatuur om eventuele schade te voorkomen.

De fabrikant aanvaardt geen enkele aansprakelijkheid voor letsel of schade als gevolg van een verkeerde toepassing van het armatuur.
 De fabrikant aanvaardt geen garantie in geval van het niet behandelen van de lampen volgens de richtlijnen van de fabrikant.
 Als er schade aan elektrische onderdelen te vinden zijn, vraag dan een elektricien om het te vervangen.

Onderhoud is behoud:
 Een goede instandhouding van het armatuur is sterk afhankelijk van omgevings- en onderhoudsfactoren. Hierop kunnen wij geen invloed uitoefenen.
 - Schakel voor de zekerheid de elektriciteit uit!
 - Gebruik geen agressieve, schurende of chemische schoonmaakmiddelen.

NOTE: Follow and keep this instructions manual.
 - Make sure that the mains voltage is switched off for installation, repair or maintenance. (Installation, repair and maintenance only by qualified persons).
 - Use only original parts for repairs or maintenance. Never attempt to disassemble, repair or alter the product in any way, improper repairs could damage the product causing electrical shocks which may cause serious injury.
 - Use the fixture only indoors. Don't use the fixture in humid or wet areas.
 - Use only suitable light sources indicated on the label.

Make sure you have at least as much space in your (false) ceiling. It is very important to give enough air cooling to avoid any damage.

The manufacturer accepts no liability for any injuries or damages resulting from the incorrect use or installation of the fixture.
 Any operation performed on the fixture that is not in accordance with instructions will void manufacturer's warranty.
 If you find any damage to the electrical parts, please ask a qualified electrician to replace it.

Maintenance is preservation:
 A good preservation of the fixture is highly dependent on environmental factors and maintenance. We cannot exercise any influence on this.
 - Make sure that the mains voltage is switched off before you begin.
 - Do not use strong, chemicals or abrasive cleaners.

"No rights can be derived from the information provided on this Instruction Manual. Information on the Instruction Manual has been compiled with the utmost care and is updated on a continuous basis. Nevertheless Maretti cannot guarantee that all information is free of errors, complete or fully up to date."

LICHTBRON: APART VERKRIJGBAAR / LED LAMPS: SEPARATE ORDER									
ART. NR.	NAME	SOCKET	VOLTAGE	WATTAGE	MILLIAMPERE	KELVIN	LUMEN	CRI	BEAM ANGLE
21.8361.02	CUBA 50 LED MODULE P&P	P&P	18V DC	6,3W	350mA	CTA 2000-2700K	450 lm	Ra95	36°
21.8366.02	CUBA 50 LED MODULE P&P	P&P	18V DC	6,3W	350mA	2700K	500 lm	Ra92	36°

ART. NR.	NAME	SOCKET	VOLTAGE	WATTAGE	MILLIAMPERE	KELVIN	LUMEN	CRI	BEAM ANGLE
21.8372.02	CUBA 50 LED MODULE P&P IP45	P&P	18V DC	6,3W	350mA	CTA 2000-2700K	450 lm	Ra95	36°
21.8376.02	CUBA 50 LED MODULE P&P IP45	P&P	18V DC	6,3W	350mA	2700K	500 lm	Ra92	36°

DRIVERS ZIJN APART VERKRIJGBAAR / SEPARATE ORDER					
ARTI. NR.	NAME	WATTAGE	MILLIAMPERE	DIMMING	NUMBER OF LIGHT SOURCES
16.8101.0350	DRIVER P&P	10,5W – 14,7W	350mA	Trailing edge/triac DIM.	2*
16.8103.0350	DRIVER P&P	5,25W – 7,35W	350mA	Leading trailing edge DIM.	1
16.7000.0350	DRIVER DALI INTEL P&P	0,9W – 10W	350mA	DALI CTA/AM DIM.	1
16.7002.0350	DRIVER DALI INTEL P&P	4W – 18,9W	350mA	DALI CTA/AM DIM.	2*

E: Europlug
G: GST18
W: Winsta
Z: Geen plug

* CONNECTION BLOCK FOR 2 LED LAMPS SEPARATE ORDER / APART VERKRIJGBAAR		
ART. NR.	NAME	INFO.
70.7115.05	CONNECTION BLOCK 3-V SERIES	P&P MALE + 2x70.7120.05 LED BRIDGE

PLUG & PLAY CABLES SEPARATE ORDER / APART VERKRIJGBAAR		
ART. NR.	NAME	MEASUREMENTS
70.7125.05	LED KOPPELKABEL / LED COUPLING CABLE	L: 50cm 2x0,5mm ² mini amp for mA led
70.7127.05	LED KOPPELKABEL / LED COUPLING CABLE	L: 100cm 2x0,5mm ² mini amp for mA led
70.7130.05	LED KOPPELKABEL / LED COUPLING CABLE	L: 150cm 2x0,5mm ² mini amp for mA led

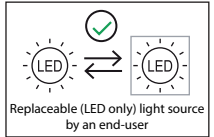

UIT / OFF

Schakel altijd eerst de stroom uit voordat u installatie-, onderhoud of reparatiewerkzaamheden uitvoert.

Always switch off the mains voltage before carrying out installation, maintenance and repair work.

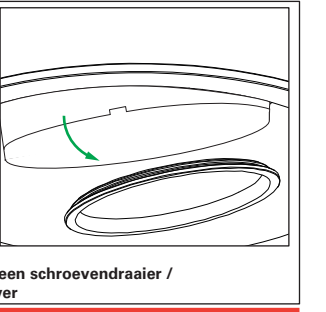
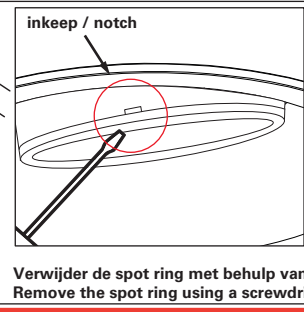
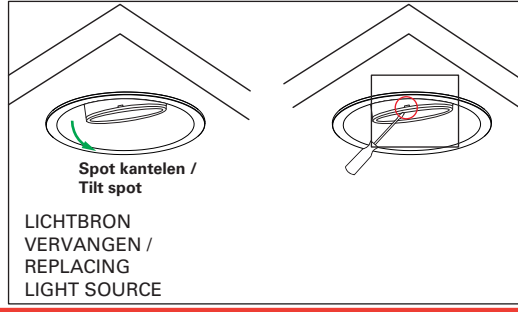
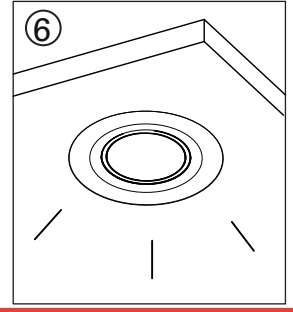
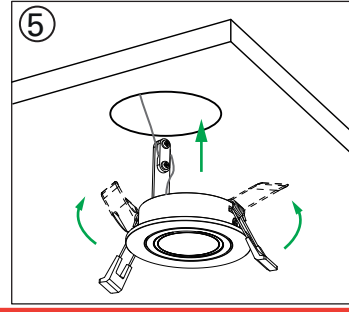
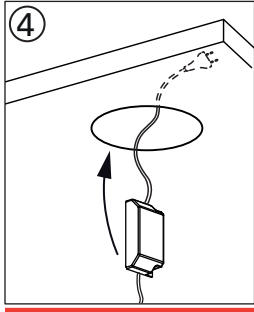
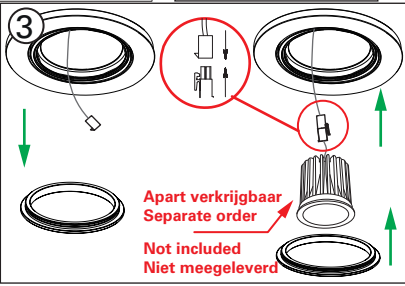
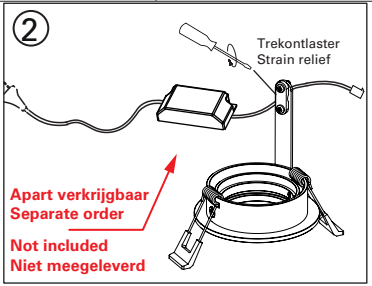
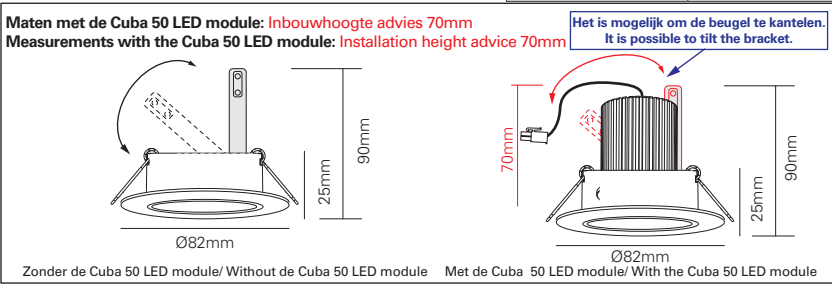
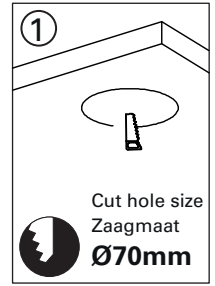

LET OP: Volg en bewaar deze gebruiksaanwijzing.

- Zorg ervoor dat de netspanning uitgeschakeld is voor installatie, reparatie of onderhoud. (Installatie, reparatie en onderhoud uitsluitend door gekwalificeerde personen).
- Voor reparatie of onderhoud uitsluitend originele delen gebruiken. Probeer het product niet zelf te demonteren en te repareren, onjuiste reparaties kunnen het product beschadigen en elektrische schokken veroorzaken wat tot ernstig letsel kan leiden.
- Gebruik het armatuur alleen binnenshuis. Het armatuur niet in vochtige of natte ruimte gebruiken.
- Uitsluitend op het etiket aangegeven lichtbronnen gebruiken.

Wanneer u een spot inbouwt moet u rekening houden met de warmte en dus rekening houden met extra inbouwruimte rond je armatuur om eventuele schade te voorkomen.

De fabrikant aanvaardt geen enkele aansprakelijkheid voor letsel of schade als gevolg van een verkeerde toepassing van het armatuur. De fabrikant aanvaardt geen garantie in geval van het niet behandelen van de lampen volgens de richtlijnen van de fabrikant. Als er schade aan elektrische onderdelen te vinden zijn, vraag dan een elektricien om het te vervangen.

Onderhoud is behoud:
Een goede instandhouding van het armatuur is sterk afhankelijk van omgevings- en onderhoudsfactoren. Hierop kunnen wij geen invloed uitoefenen.
- Schakel voor de zekerheid de elektriciteit uit!
- Gebruik geen agressieve, schurende of chemische schoonmaakmiddelen.

NOTE: Follow and keep this instructions manual.

- Make sure that the mains voltage is switched off for installation, repair or maintenance. (Installation, repair and maintenance only by qualified persons).
- Use only original parts for repairs or maintenance. Never attempt to disassemble, repair or alter the product in any way, improper repairs could damage the product causing electrical shocks which may cause serious injury.
- Use the fixture only indoors. Don't use the fixture in humid or wet areas.
- Use only suitable light sources indicated on the label.

Make sure you have at least as much space in your (false) ceiling. It is very important to give enough air cooling to avoid any damage.

The manufacturer accepts no liability for any injuries or damages resulting from the incorrect use or installation of the fixture. Any operation performed on the fixture that is not in accordance with instructions will void manufacturer's warranty. If you find any damage to the electrical parts, please ask a qualified electrician to replace it.

Maintenance is preservation:
A good preservation of the fixture is highly dependent on environmental factors and maintenance. We cannot exercise any influence on this.
- Make sure that the mains voltage is switched off before you begin.
- Do not use strong, chemicals or abrasive cleaners.

"No rights can be derived from the information provided on this Instruction Manual. Information on the Instruction Manual has been compiled with the utmost care and is updated on a continuous basis. Nevertheless Maretti cannot guarantee that all information is free of errors, complete or fully up to date."