



MARETTI LIGHTING



Maretti Lighting
Bolderweg 7

1332 AX Almere
the Netherlands

T +31 (0) 36 532 66 12

E info@maretti.com
W www.maretti.com

Maretti Lighting is well-known in the World of interior design. In businesses, homes, store chains, and hospitality facilities all over the world, Maretti is unmistakable present with its project lighting that does more than just provide light. We make lighting an essential part of the interior. Maretti stands for stylish top quality and trendsetting design, modern, timeless and most of all, original.

Maretti Lighting works with all the top brands in the lighting industry, but we are especially notable for our own large product line and introduce our own brand name "Maretti". Our production team distinguishes itself time and time again with unique innovations from our own atelier and therefore our projects exude an entirely unique identity.

© Copyright Maretti Projectverlichting.

Our IM was made with the greatest of care. Nevertheless, the colours displayed in the IM may differ slightly from the real colours because of the printing process. Colour, size and range are subject to change. Nothing from this IM may be copied, reproduced and/or published by print, photocopy or in any other way without Maretti Lighting's written permission. All product and design copyrights belong to Maretti Lighting.

GUARANTEE TERMS AND CONDITIONS

The other party should inspect the delivered items immediately upon receipt with regard to its soundness. Entitlements to repair or replacement only exist if the other party

- In the case of visible defects, informs MPV of them immediately.

- In the case of defects that are not visible, informs MPV in writing of the defects, within 2 working days after the day the defects were found, or in all reason could have been found and furthermore demonstrates that the MPV instructions for use, maintenance and operation were followed, whilst the defects are not the consequence of normal wear and tear, misuse, negligence, accident, exceeding the limits prescribed by the MPV or by the legal safety regulations, or, in the case of a repair or change without MPV's consent or the consent of its recognised repairer, there will be no entitlement to repairs or replacement. The parts that have to be replaced must be made available free of charge to MPV. Noncompliance by the other party to one or more of its obligations will release MPV of all its guarantee obligations. In the case of assembly of the other party's own products by Maretti, MPV will release itself from all guarantee stipulations.

Moreover, our general delivery terms and conditions are applicable. These can be obtained from Maretti or can be downloaded from www.maretti.com

The installation must be done by a competent installer. Maretti recommends that your (outside) lighting and fixtures are inspected and maintained annually.

D: Für Garantiebedingungen bitte lesen Sie unsere Webseite www.maretti.com
E: Consulte nuestro sitio web para las condiciones de garantía www.maretti.com
FR: Consultez notre site web pour les conditions de garantie www.maretti.com
NL: Voor garantievoorwaarden zie onze website www.maretti.com

13.7056.04 ROUND BASE 3-L
13.7059.04 RECTANGLE BASE 3-L
13.7062.04 RECTANGLE BASE 5-L

IONIA PENDANT SERIES

1/3



13.7056.04



13.7059.04



13.7062.04

BLACK
BASE
04

230V	VOLTAGE		INDOOR				
5W	MAX. WATTAGE / LIGHT SOURCE	IP20	IP RATING				
	BULB NOT INCLUDED	CE	CE MARK				
G9	SOCKET						

13.7056.04 ROUND BASE 3-L
 13.7059.04 RECTANGLE BASE 3-L
 13.7062.04 RECTANGLE BASE 5-L

IONIA PENDANT SERIES

MEASUREMENTS

13.7056.04				
ART.NR.	AMOUNT	TYPE GLASS	DIAMETER GLASS	COLOUR GLASS
80.1403.53	3x	D	Ø150mm	BROWN

13.7059.04				
ART.NR.	AMOUNT	TYPE GLASS	DIAMETER GLASS	COLOUR GLASS
80.1400.53	1x	A	Ø120mm	BROWN
80.1401.53	1x	B	Ø110mm	BROWN
80.1402.53	1x	C	Ø180mm	BROWN

13.7062.04				
ART.NR.	AMOUNT	TYPE GLASS	DIAMETER GLASS	COLOUR GLASS
80.1404.53	5x	E	Ø200mm	BROWN

LIGHT BULB G9 / 230V SEPARATE ORDER	
ART.NR.	21.8262.82
VOLTAGE	230V
WATTAGE	3,1 W
KELVIN	2700 K
LUMEN	250 lm
CRI	Ra80

13.7056.04

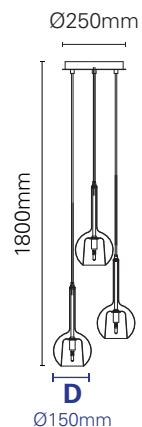

13.7059.04

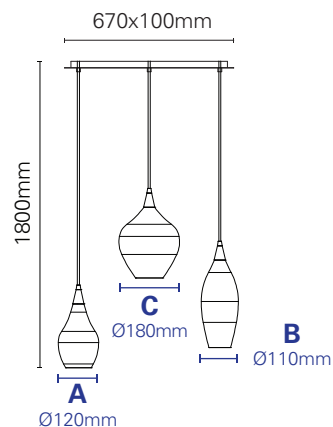

13.7062.04

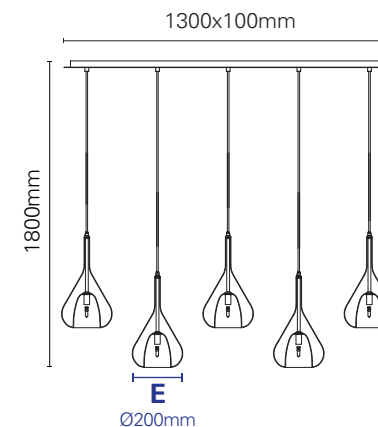

LET OP:

- Volg en bewaar deze gebruiksaanwijzing.
- Zorg ervoor dat de netspanning uitgeschakeld is voor installatie, reparatie of onderhoud. (Installatie, reparatie en onderhoud uitsluitend door gekwalificeerde personen).
- Voor reparatie of onderhoud uitsluitend originele delen gebruiken.
- Gebruik het armatuur alleen binnenshuis.
- Het armatuur niet in vochtige of natte ruimte gebruiken.

De fabrikant aanvaardt geen enkele aansprakelijkheid voor letsel of schade als gevolg van een verkeerde toepassing van het armatuur.
 De fabrikant aanvaardt geen garantie in geval van het niet behandelen van de lampen volgens de richtlijnen van de fabrikant.
 Als er schade aan elektrische onderdelen te vinden zijn, vraag dan een elektricien om het te vervangen.

Onderhoud is belangrijk:

Een goede instandhouding van het armatuur is sterk afhankelijk van omgevings- en onderhoudsfactoren. Hierop kunnen wij geen invloed uitoefenen.

- Schakel voor de zekerheid de elektriciteit uit!
- Gebruik geen bijtende, chemische of schurende schoonmaakmiddelen.

NOTE:

- Follow and keep this instructions manual.
- Make sure that the mains voltage is switched off for installation, repair or maintenance. (Installation, repair and maintenance only by qualified persons).
- Use only original parts for repairs or maintenance.
- Use the fixture only indoors.
- Don't use the fixture in humid or wet areas.

The manufacturer accepts no liability for any injuries or damages resulting from the incorrect use or installation of the fixture.
 Any operation performed on the fixture that is not in accordance with instructions will void manufacturer's warranty.
 If you find any damage to the electrical parts, please ask a qualified electrician to replace it.

Maintenance is preservation:

A good preservation of the fixture is highly dependent on environmental factors and maintenance. We cannot exercise any influence on this.

- Make sure that the mains voltage is switched off before you begin.
- Do not use strong, chemicals or abrasive cleaners.

"No rights can be derived from the information provided on this Instruction Manual. Information on the Instruction Manual has been compiled with the utmost care and is updated on a continuous basis. Nevertheless Maretti cannot guarantee that all information is free of errors, complete or fully up to date."

13.7056.04 ROUND BASE 3-L
 13.7059.04 RECTANGLE BASE 3-L
 13.7062.04 RECTANGLE BASE 5-L

IONIA PENDANT SERIES

MOUNTING INFO.

①

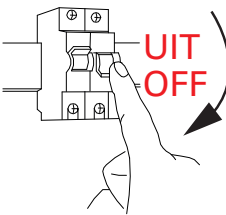

UIT OFF

Schakel altijd eerst de stroom uit voordat u installatie-, onderhouds- of reparatiewerkzaamheden uitvoert.

Always switch off the mains voltage before carrying out installation, maintenance and repair work.

②

NIET TE GEBRUIKEN IN COMBINATIE MET DE PLAFONDBAKKEN
NOT TO BE USED IN COMBINATION WITH THE CEILING BASES

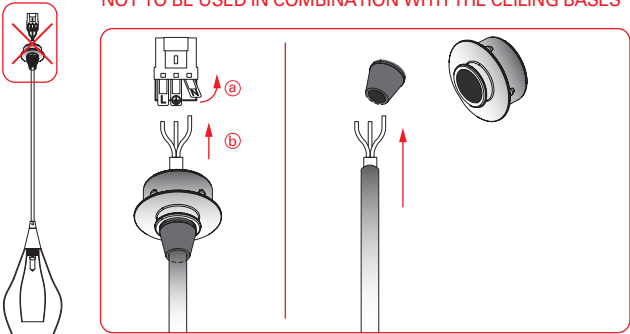

③

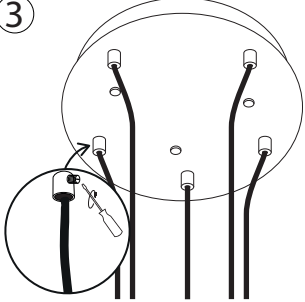

Bepaal de lengte van elk snoer met hanglamp, steek de snoeren door de bak en schroef de trekontlasting handvast.

Determine the length of each pendant light cord, thread the cords through the ceiling base, and hand-tighten the strain relief.

④

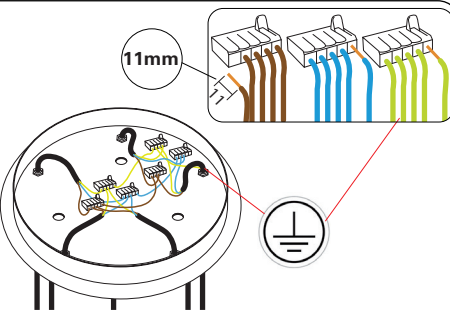

Strip de isolatie v/d bedrading op 11mm aan. Sluit de bedrading aan op de klik connectors.

Strip the insulation of the wiring to 11mm. Connect the wiring to the connectors.

⑤

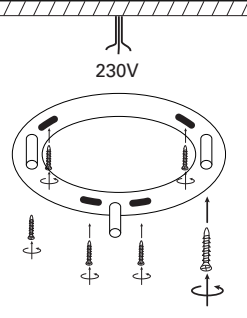

Gebruik voor het type plafond de daarvoor bestemde bevestigingsmiddelen.

Use the designated fasteners for the type of ceiling.

⑥

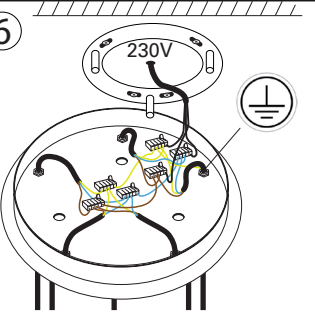

Sluit de klik connectors aan op het stroompunt.

Connect the connectors to the power point.

⑦

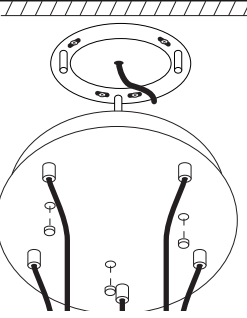

Bevestig de bak aan de montagebeugel d.m.v. de bijgeleverde siermoeren. Let op dat er geen bedrading uit de bak steekt als deze wordt gedicht!

Attach the fixture to the mounting bracket using the provided decorative nuts. Ensure that no wiring is protruding from the fixture when it is closed/sealed.

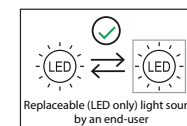

LET OP:

- Volg en bewaar deze gebruiksaanwijzing.
- Zorg ervoor dat de netspanning uitgeschakeld is voor installatie, reparatie of onderhoud. (Installatie, reparatie en onderhoud uitsluitend door gekwalificeerde personen).
- Voor reparatie of onderhoud uitsluitend originele delen gebruiken.
- Gebruik het armatuur alleen binnenshuis.
- Het armatuur niet in vochtige of natte ruimte gebruiken.

De fabrikant aanvaardt geen enkele aansprakelijkheid voor letsel of schade als gevolg van een verkeerde toepassing van het armatuur.
 De fabrikant aanvaardt geen garantie in geval van het niet behandelen van de lampen volgens de richtlijnen van de fabrikant.
 Als er schade aan elektrische onderdelen te vinden zijn, vraag dan een elektricien om het te vervangen.

Onderhoud is behoud:

Een goede instandhouding van het armatuur is sterk afhankelijk van omgevings- en onderhoudsfactoren. Hierop kunnen wij geen invloed uitoefenen.

- Schakel voor de zekerheid de elektriciteit uit!
- Gebruik geen bijtende, chemische of schurende schoonmaakmiddelen.

NOTE:

- Follow and keep this instructions manual.
- Make sure that the mains voltage is switched off for installation, repair or maintenance. (Installation, repair and maintenance only by qualified persons).
- Use only original parts for repairs or maintenance.
- Use the fixture only indoors.
- Don't use the fixture in humid or wet areas.

The manufacturer accepts no liability for any injuries or damages resulting from the incorrect use or installation of the fixture.
 Any operation performed on the fixture that is not in accordance with instructions will void manufacturer's warranty.
 If you find any damage to the electrical parts, please ask a qualified electrician to replace it.

Maintenance is preservation:

A good preservation of the fixture is highly dependent on environmental factors and maintenance. We cannot exercise any influence on this.

- Make sure that the mains voltage is switched off before you begin.
- Do not use strong, chemicals or abrasive cleaners.

*No rights can be derived from the information provided on this Instruction Manual. Information on the Instruction Manual has been compiled with the utmost care and is updated on a continuous basis. Nevertheless Maretti cannot guarantee that all information is free of errors, complete or fully up to date."